

product information

model 2030



moveable backrest



wooden foot black



massive aluminium foot

bullfrog
GERMANY

www.bullfrog-design.com

model 2030

design by kurt beier



Accentuated horizontal - spacious but still floating - emotional sitting, change your sitting position, straight or angular, use the moveable backrest to enlarge the seat and enjoy the evening.

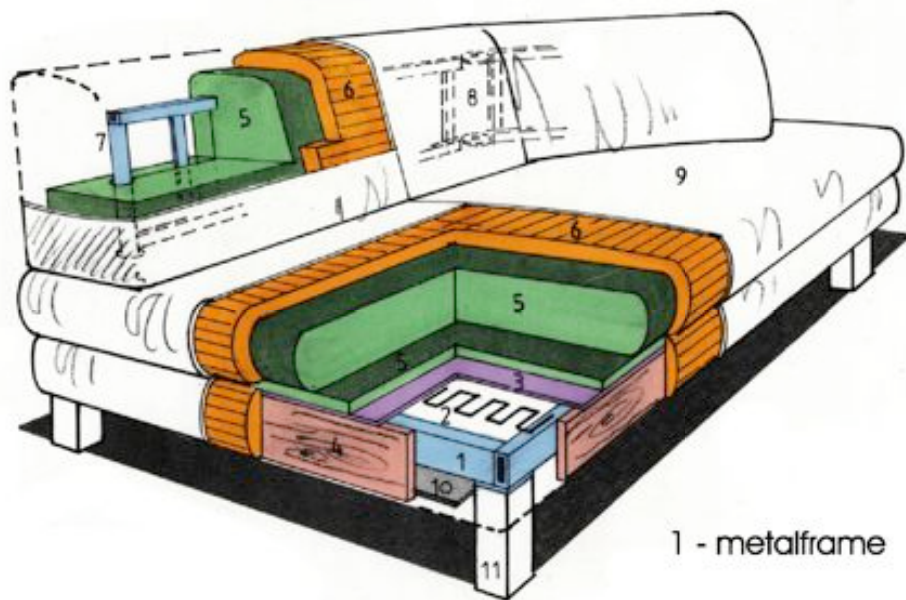

- 1 - metalframe
- 2 - NOSAG steel springs
- 3 - NOSAG covering out of Polyvlies
- 4 - all around plywood frame
- 5 - polyfoam
- 6 - 200 g/m2 fleece sewed to the cover
- 7 - metalframe
- 8 - function part (7 steps) for moveable backrest
- 9 - cover
- 10 - typar as bottom closing
- 11 - alternatively wooden foot black coloured or round aluminium foot

quality in detail!

model 2030

design by kurt beier

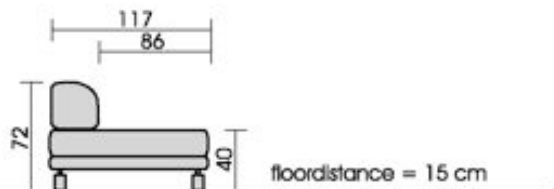

side view

2 different feet possible:

- foot 572 (solid wood in black)
- foot 574 (alu massive)

backrest moveable to one side

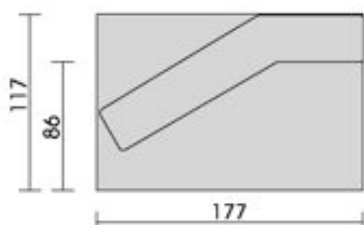

ottomane armrest left
262

backrest moveable to one side

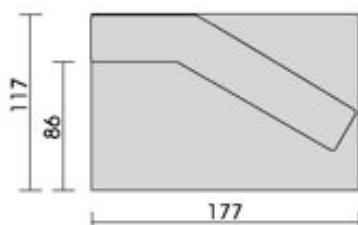

ottomane armrest right
261



cushion
83 x 83
516

backrest moveable on both sides

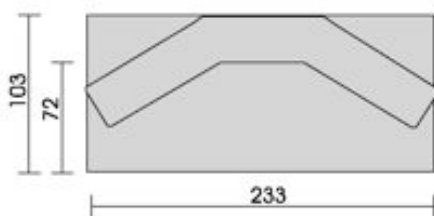

sofa 3- seat
300



cushion
60 x 52
517



cushion
60 x 40 cm
967

backrest moveable to one side

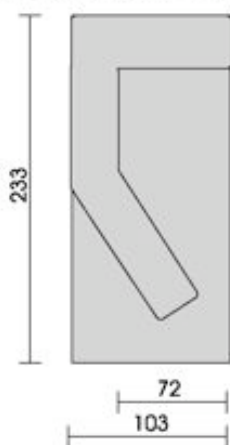

cornersofa 3-seat left
304

backrest moveable to one side

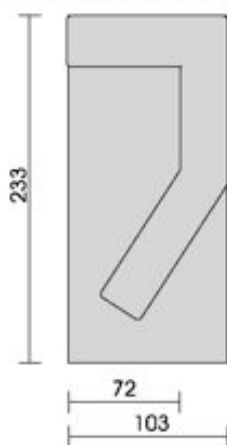

cornersofa 3-seat right
303

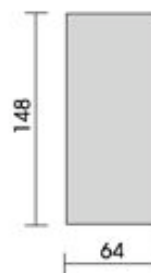

stool
555

examples :

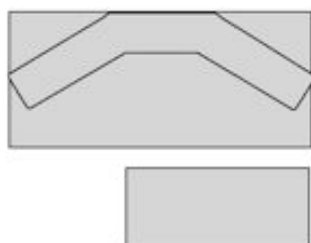

... single sofa with stool

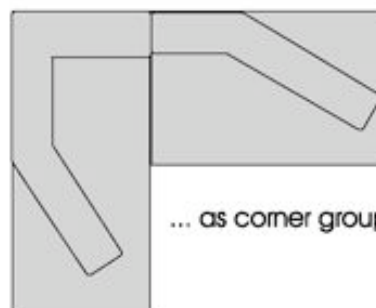

... as corner group

model 2030

design by kurt beier

Assembly instruction

Feet assembly

Lay the sofa onto the backrest, screw in 4 feet per type. Screw in the middlefeet **D** and adjust them to the level of the floor

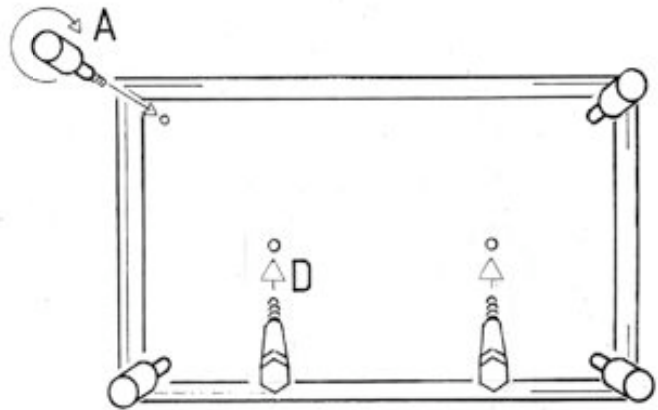

Handling of the moveable backrest

The seatposition can be changed by pulling the moveable backrestparts to the front of the sofa.

To remove the backrest, it has to be pulled completely to the front and then it can be pushed back into zero position (see drawing).

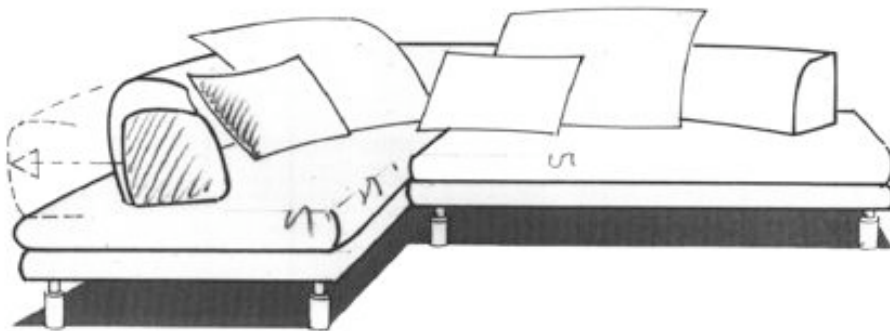

How to connect the parts of the sofa

Lay the sofa on the backrest and screw on the connector guide / detail (packed with the feet) in the marked position on the bottom side of the sofa (piece 1).

Put together piece 1 and 2.

To demount, lift piece 1 and pull it away.

Detail

